

Year 12 PHYSICS ATAR

Semester 2 Examination, 2016

Question/Answer Booklet

Student Number: In figures

--	--	--	--	--	--	--	--

In words

Solutions

Time allowed for this paper

Reading time before commencing work: ten minutes

Working time for paper: three hours

Materials required/recommended for this paper

To be provided by the supervisor

This Question/Answer Booklet

Formulae and Constants Sheet

To be provided by the candidate

Standard items: pens, pencils, eraser, correction fluid, ruler, highlighters

Special items: non-programmable calculators satisfying the conditions set by the Curriculum Council for this course

Important note to candidates

No other items may be taken into the examination room. It is your responsibility to ensure that you do not have any unauthorised notes or other items of a non-personal nature in the examination room. If you have any unauthorised material with you, hand it to the supervisor **before** reading any further.

Structure of this paper

Section	Number of questions available	Number of questions to be answered	Suggested working time (minutes)	Marks available	Percentage of exam
Section One: Short answer	12	12	50	54	30
Section Two: Extended answer	7	7	90	90	50
Section Three: Comprehension and data analysis	2	2	40	36	20
Total				180	100

Instructions to candidates

1. The rules for the conduct of Western Australian external examinations are detailed in the *Year 12 Information Handbook 2016*. Sitting this examination implies that you agree to abide by these rules.
2. Write answers in this Question/Answer Booklet.
3. When calculating numerical answers, show your working or reasoning clearly. Give final answers to **three** significant figures and include appropriate units where applicable.

When estimating numerical answers, show your working or reasoning clearly. Give final answers to a maximum of **two** significant figures and include appropriate units where applicable.

4. You must be careful to confine your responses to the specific questions asked and follow any instructions that are specific to a particular question.
5. Spare pages are included at the end of this booklet. They can be used for planning your responses and/or as additional space if required to continue an answer.
 - Planning: If you use the spare pages for planning, indicate this clearly.
 - Continuing an answer: If you need to use the space to continue an answer, indicate in the original answer space where the answer is continued, i.e. give the page number. Refer to the question(s) where you are continuing your work.

Section One: Short response**30% (54 Marks)**

This section has **12** questions. Answer **all** questions. Write your answers in the space provided. Suggested working time for this section is 50 minutes.

Question 1**(2 marks)**

The emf output of an AC generator is shown on the graph below.

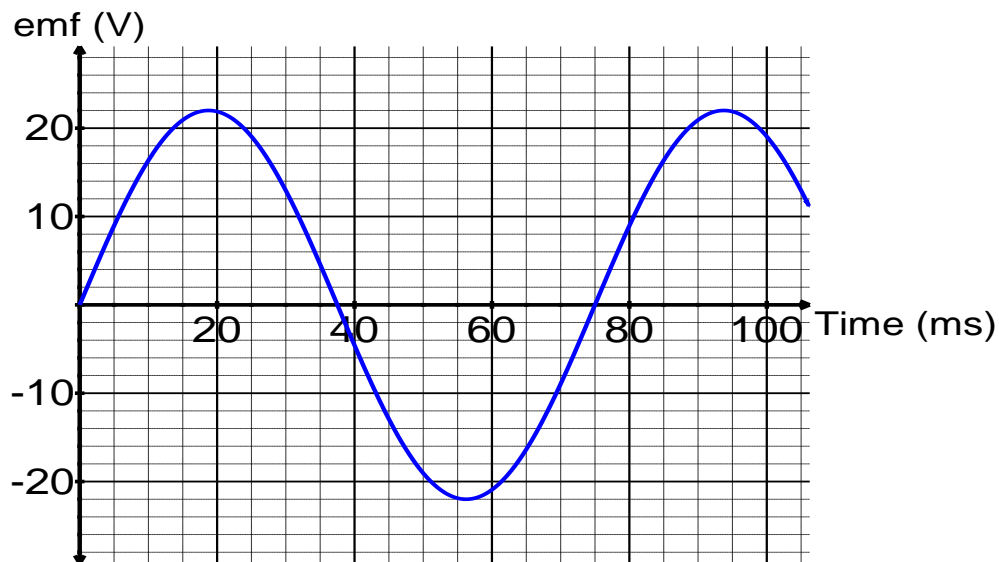

Determine the RMS voltage of this AC generator. Show how you obtained your data from the graph.

(2)

Clearly shows maximum emf of 22 V taken from the graph ✓

$$v_{RMS} = \frac{V_{max}}{\sqrt{2}} = \frac{22}{\sqrt{2}} = 15.6 V \checkmark$$

Question 2**(4 marks)**

An astronaut flies past an observer at a constant 85% of the speed of light in the reference frame of the observer. His spacecraft has light A at the front and light B at the rear. When the astronaut is directly in front of the observer as shown, he sees the two lights A and B illuminate simultaneously.

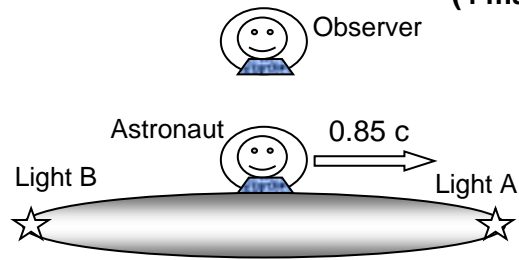

- a) From the frame of reference of the astronaut explain what order the lights will go on for the observer.

(2)

The astronaut predicts that the observer will see B then A. ✓
 According to Einstein's special relativity the speed of light is constant in any reference frame. The observer is moving to the left in the astronaut's frame of reference so the light from A has to travel further to reach the observer so the observer will see this flash second. ✓

- b) The astronaut and the observer both have identical stopwatches set to countdown from one minute. As the astronaut passes the observer both stopwatches commence their countdown. The astronaut states that his own stopwatch will finish the countdown first but the observer states the opposite. Explain who is correct and why.

(2)

The observer sees the astronaut moving close to speed of light and concludes that the time between the astronaut's ticks takes longer on the moving clock - so effectively the rate of time passing slows down. In the frame of reference of the astronaut the observer is moving so the observer's clock will take longer than the astronaut's countdown. ✓
 Both are correct in their own frame of reference ✓

Question 3**(5 marks)**

The rigid arm of a crane is lifting an oil drum.

- The crane arm has a mass of 230 kg distributed uniformly along its length of 7.00 m.
- An oil drum of mass 310 kg is suspended 4.80 m from the pivot point of the crane arm.
- A cable is attached 6.10 m from the pivot point and transmits a tension force of 3964.5 N.
- The cable makes an angle θ with the crane arm.
- The crane arm has been raised to 32° above the horizontal.

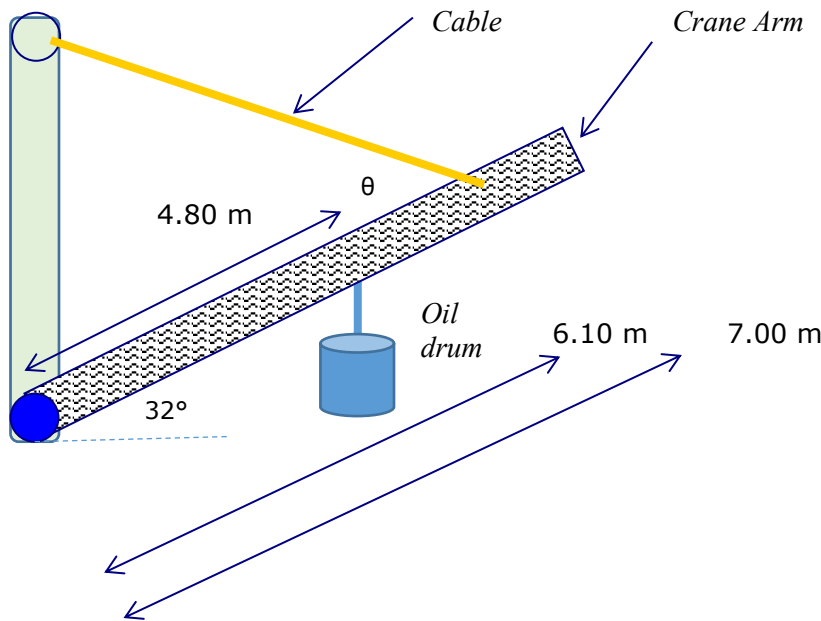

- a) Calculate the angle θ between the crane arm and the cable.

(4)

Select base as pivot point and take moments such that $\Sigma M = 0$

$\Sigma cwm = \Sigma acwm$ correct concept

$$(4.8 \times 310 \times 9.8 \times \sin 58) + (3.5 \times 230 \times 9.8 \times \sin 58) \checkmark = (6.1 \times 3964.5 \times \sin \theta) \checkmark$$

$$\sin \theta = 0.7880 \checkmark$$

$$\theta = \sin^{-1}(0.7880) = 52.0^\circ \checkmark$$

- b) If the oil drum is instead suspended from the right hand edge of the crane arm the tension in the cable will: (circle a response)

(1)

Increase

Stay the same

Decrease

Impossible to determine

Increase \checkmark

Question 4**(5 marks)**

A charged particle enters a region between 2 parallel charged plates. The plates are separated by 3.00 cm. The electric field strength in the region between the charged plates is $7.80 \times 10^4 \text{ V m}^{-1}$.

(2)

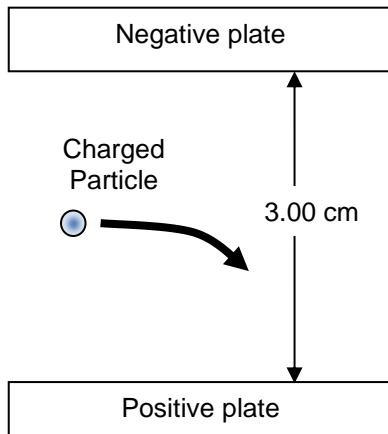

a) Calculate the potential difference between the plates.

$$E = V / d$$

$$V = E \times d = 7.80 \times 10^4 \times 0.03 \quad \checkmark$$

$$V = 2340 \text{ V} \quad \checkmark$$

b) The charged particle experiences a force of magnitude $3.50 \times 10^{-7} \text{ N}$ that causes it to deflect towards the positive plate. Determine the charge of the particle in terms of magnitude and sign.

$$E = F / q$$

$$q = F / E = 3.50 \times 10^{-7} / 7.80 \times 10^4 \quad \checkmark$$

$$q = 4.49 \times 10^{-12} \text{ C} \quad \checkmark$$

negative charge \checkmark

(3)

Question 5**(5 marks)**

A physics student observes a stone of mass 450 g being launched from the top of a tower. The launch position at the top of the tower is 12.0 m above ground level. The stone lands 38.0 m in front of the launch position. The initial launch speed u is at an angle of 43.0° to the horizontal. You may ignore air resistance for the calculations.

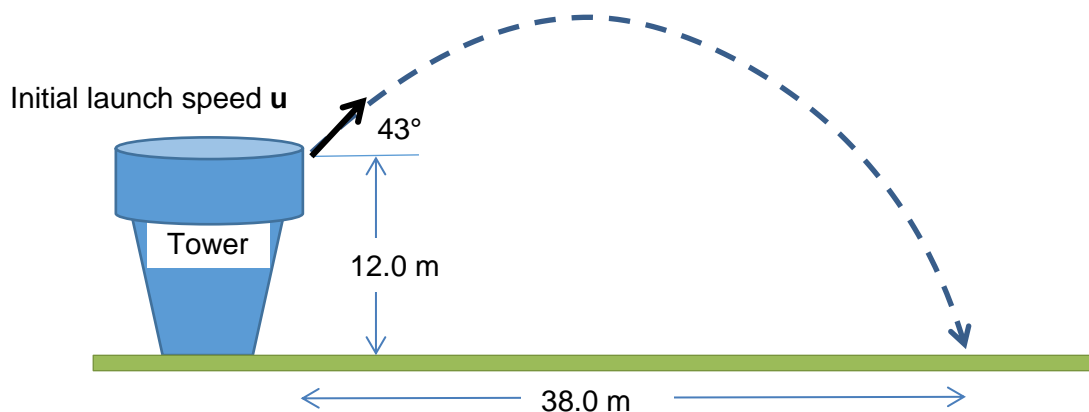

Calculate the initial launch speed u of the stone. You must show clear algebraic steps in your solution.

Hint: consider the flight time for both the horizontal and vertical components of motion.

Consider the total flight time t_f

$$s_y = -12.0 \quad u_y = u \cdot \sin 43 \quad a_y = -9.80 \text{ m/s}^2 \quad \checkmark$$

$$u_x = s_x / t_f \quad u \cdot \cos 43 = 38 / t_f \quad \therefore t_f = 38 / u \cdot \cos 43 \quad \checkmark$$

$$s_y = u_y t_f + \frac{1}{2} a_y t_f^2$$

$$-12 = 38(u \cdot \sin 43 / u \cdot \cos 43) - ((4.9 \times 38^2) / (u^2 \cos^2 43)) \quad \checkmark$$

$$-12 = 38(\tan 43) - (3340.02 / u^2)$$

$$-12 = 35.43557 - 13228.43128 / u^2$$

$$-47.43557 = -13228.43128 / u^2$$

$$u^2 = 13228.43128 / 47.43557 \quad \checkmark$$

$$u^2 = 278.87$$

$$u = 16.7 \text{ m/s} \quad \checkmark$$

(5)

Question 6**(5 marks)**

A 500 W radio transmitter uses a metallic aerial to broadcast a signal. It does this by oscillating electrons in the aerial. The radio transmission has a wavelength of 585 m.

- a) Calculate the frequency of the oscillating electrons that cause the signal to be transmitted.

(2)

$$f = \frac{c}{\lambda}$$

$$f = \frac{3.00 \times 10^8}{585} \quad \checkmark$$

$$f = \frac{3.00 \times 10^8}{585} = 5.13 \times 10^5 \text{ Hz} \quad \checkmark$$

- b) Determine how many photons are transmitted in a 3 second pulse.

(3)

$$E_{\text{photon}} = hf = 6.63 \times 10^{-34} \times 5.13 \times 10^5 \quad \checkmark$$

$$E_{\text{pulse}} = P \times t = 500 \times 3 = 1500 \text{ J} \quad \checkmark$$

$$\text{number photons} = \frac{E_{\text{pulse}}}{E_{\text{photon}}} = \frac{1500}{6.63 \times 10^{-34} \times 5.13 \times 10^5} = 4.41 \times 10^{30} \quad \checkmark$$

Question 7**(2 marks)**

Explain the source of energy from fusion reactions in the Sun. You must refer to relevant physics principles in your response.

(2)

According to Einstein's mass-energy equivalence which emerged from the special theory of relativity, mass can be converted to energy. \checkmark

In fusion reactions the mass of the products is less than the mass of the reactants. This mass was converted to energy. \checkmark

Question 8**(7 marks)**

A lead ion (Pb^{2+}) of mass 3.44×10^{-25} kg is accelerated to a speed of 77% the speed of light in a particle accelerator. The total energy of the lead ion is given by its mass-energy equivalence which is the sum of its rest energy ($E = mc^2$) and its kinetic energy.

- a) Calculate the kinetic energy of the lead ion.

$$m = 3.44 \times 10^{-25} \text{ kg} \quad v = 0.77 \times 3.00 \times 10^8 \text{ m s}^{-1} \checkmark$$

(4)

$$E = \frac{m \cdot c^2}{\sqrt{1 - \frac{v^2}{c^2}}} \quad E = mc^2 + KE$$

$$KE = \frac{m \cdot c^2}{\sqrt{1 - \frac{v^2}{c^2}}} - mc^2 \checkmark$$

$$KE = \frac{3.44 \times 10^{-25} \times (3 \times 10^8)^2}{\sqrt{1 - \frac{0.77^2}{1}}} - 3.44 \times 10^{-25} \times (3 \times 10^8)^2 \checkmark$$

$$KE = 1.76 \times 10^{-8} \text{ J} \checkmark$$

- b) Calculate the value of kinetic energy of the lead ion according to Newtonian physics and state whether there is a significant difference compared to the solution in part a).

(3)

According to Newtonian physics $KE = \frac{1}{2} mv^2$

So this would yield $KE = \frac{1}{2} 3.44 \times 10^{-25} (0.77 \times 3 \times 10^8)^2 \checkmark$

$KE = 9.18 \times 10^{-9} \text{ J} \checkmark$

This is only approximately 50% of the calculated value so this is significantly different. \checkmark

Question 9**(6 marks)**

The energy level diagram below for a simple atom is shown below. The atom is in the ground state.

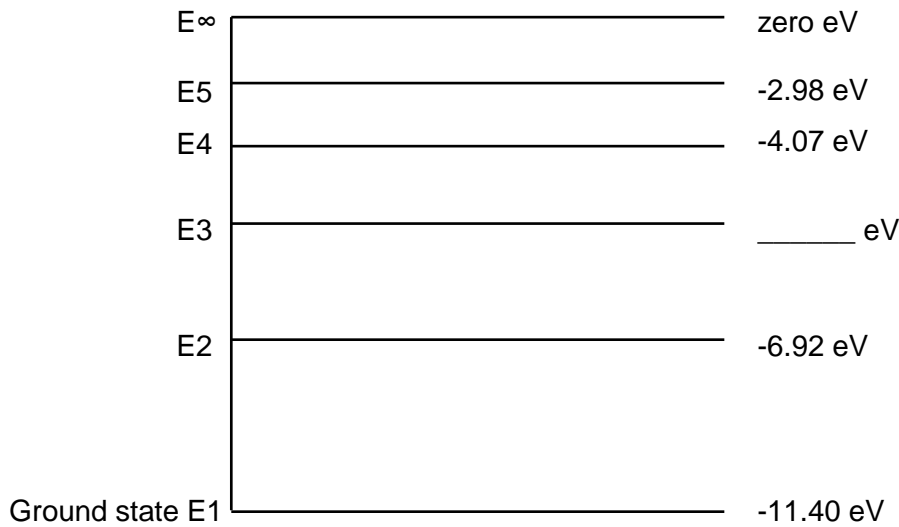

- a) The atom is bombarded by 4 photons with energies detailed below. Circle all of the photon energies that could be absorbed by the atom whilst in its ground state.

4.08 eV

4.48 eV

8.63 eV

12.5 eV

(1)

- b) Whilst in the ground state the atom absorbs a photon of wavelength 184.99 nm which excites the atomic electron to E3. Calculate the energy level of E3 and write it on the diagram.

(4)

$$\lambda = 184.99 \times 10^{-9} \text{ m}$$

$$E = \frac{h \cdot c}{\lambda} = \frac{6.63 \times 10^{-34} \times 3 \times 10^8}{184.99 \times 10^{-9}} \checkmark$$

$$E = 1.0752 \times 10^{-18} \text{ J} \checkmark$$

$$E \text{ (eV)} = 1.0752 \times 10^{-18} / 1.60 \times 10^{-19}$$

$$E \text{ (eV)} = 6.72 \text{ eV} \checkmark$$

$$E3 = E1 + 6.72$$

$$E3 = -11.4 + 6.72 = -4.68 \text{ eV} \checkmark \text{ (on the diagram)}$$

- c) Which part of the electromagnetic spectrum does the 184.99 nm photon belong to?

(1)

Ultraviolet \checkmark

Question 10**(7 marks)**

A spacecraft is moving away from Earth at a speed of $0.85c$. The spacecraft fires a probe back towards Earth. As viewed from Earth the probe is moving at $0.60c$ towards Earth.

- a) Determine the speed of the probe in the frame of reference of the spacecraft.

(3)

$v = 0.85c$ $u = -0.60c$ identifies variables correctly ✓

$$u' = \frac{u - v}{1 - \frac{uv}{c^2}}$$

$$u' = \frac{-0.6c - 0.85c}{1 - \frac{-0.6c \times 0.85c}{c^2}} \quad \checkmark$$

$$u' = \frac{-1.45c}{1 + 0.51} = 0.960c \quad \checkmark$$

- b) The probe has a length dimension along its direction of motion. There are three frames of reference in this situation – from the Earth, from the spacecraft and from the probe. Circle the best response from the following options

- A. The length is the same in all three frames of reference.
 B. The length is longest from the probe and shortest from the Earth
 C. The length is shortest from the probe and longest from the Earth
 D. The length is longest from the probe and shortest from the spacecraft.

(1)

- c) Explain your reasoning to part b) with reference to appropriate physics principles and formulae. No calculation is required.

(3)

D.

According to Einstein's Special Relativity the length of an object contracts according to its speed in a given frame of reference as given by the equation.

$$l = l_0 \sqrt{1 - \frac{v^2}{c^2}} \quad \checkmark$$

The probe is at rest in its own frame of reference so length is longest ✓ (the proper length or rest length)

The maximum speed of the probe is in the reference frame of the spacecraft, so l is shortest from the spacecraft. ✓

Question 11**(3 marks)**

Explain the role that gauge bosons play in the standard model and give an example of a gauge boson and how it can interact with other particles.

(3)

Forces (strong, Weak, EM) in the standard model are mediated by gauge bosons. ✓

An example of a gauge boson is a photon. ✓

It can mediate the electromagnetic force of repulsion between two positively charged protons. ✓

Or other acceptable examples (gluons - strong nuclear interaction between hadrons, W/Z weak nuclear interaction between quarks and leptons)

Question 12**(3 marks)**

The diagram shows the cross section of a single conducting wire carrying a current of 5.32 A

- a) Determine the magnetic flux density due to the current at point P which is 7.50 cm from the wire

$$B = \frac{\mu_0}{2\pi} \cdot \frac{I}{r}$$

$$B = \frac{4\pi \times 10^{-7}}{2\pi} \cdot \frac{5.32}{0.075} \quad \checkmark$$

$$B = 1.42 \times 10^{-5} T \quad \checkmark$$

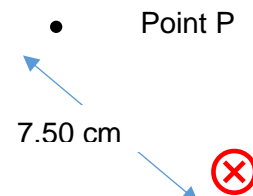

(2)

- b) Draw an arrow through point P on the diagram to show the direction of the magnetic field due to the current carrying wire.

Shows arrow ↗ at P ✓

(1)

End of Section One

This page is left blank intentionally

Section Two: Problem-solving**50% (90 Marks)**

This section has **seven (7)** questions. You must answer **all** questions. Write your answers in the space provided. Suggested working time for this section is 90 minutes.

Question 13**(13 marks)**

The Hubble Space telescope observes distant galaxies to gather evidence to support the Big Bang Theory. The line absorption spectrum of light passing through a metallic vapour in galaxy M104 shows one line with a wavelength of 563.7 nm. The same line in the spectrum measured on Earth is 561.4 nm.

- a) Calculate the recessional velocity of galaxy M104 using the following relationship: (3)

$$\frac{\Delta\lambda}{\lambda_{rest}} = \frac{v}{c_0} \quad \text{where} \quad \Delta\lambda = \lambda_{shifted} - \lambda_{rest} \quad \text{and } v = \text{recessional velocity (m s}^{-1}\text{)}$$

$$\Delta\lambda = 563.7 - 561.4 = 2.30 \quad \checkmark$$

$$\frac{\Delta\lambda}{\lambda_{rest}} = \frac{v}{3 \times 10^8}$$

$$v = \frac{2.30 \times 3 \times 10^8}{561.4} = 1.23 \times 10^6 \text{ m s}^{-1} \quad \checkmark$$

- b) Using Hubble's law, calculate the distance in Mpc to galaxy M104 using the velocity you calculated. (If you could not solve for the velocity then use a value of $1.23 \times 10^6 \text{ m s}^{-1}$) (2)

Hubble's law states that: $v = H_0 \cdot d$ $v = \text{recessional velocity (km s}^{-1}\text{)}$
 $d = \text{distance in megaparsec (Mpc)}$
 $H_0 = 74.0 \text{ km s}^{-1} \text{ Mpc}^{-1}$

$$v = 1.23 \times 10^3 \text{ km s}^{-1}$$

$$d = \frac{v}{H_0}$$

$$d = \frac{1.23 \times 10^3}{74.0} \quad d = 16.6 \text{ Mpc} \quad \checkmark$$

- c) How many years has it taken light from this galaxy to reach Earth? (1 parsec = 3.26 light year)
(2)

Distance = $16.6 \times 10^6 \times 3.26$ ✓ = 54.1 million light years

It took 54.1 million years ✓

- d) Explain how the wavelengths of light observed from Galaxy M104 can become redshifted.

The electromagnetic radiation is emitted by the source of the radiation at a given frequency in the frame of reference of the source and the em radiation propagates at the speed of light ✓
The source of the radiation is moving away from the observer in the reference frame of the observer so as each wave is emitted the distance between each successive wave is increasing. ✓
The increase in the distance between wavefronts corresponds to an increase in wavelength. ✓
Or similar - can also be explained in terms of frequency reduction

(3)

- e) Explain how a line absorption spectrum is produced.

A continuous emission (black body) spectrum is emitted from the source
This radiation passes through relatively cool low pressure gas/vapour on its way to the observer. ✓
Only Photons are absorbed whose energy matches energy level differences in the low pressure vapour - to excite atomic electrons to higher levels. ✓
On de-excitation the photons are scattered in all directions so for the observer there is a net reduction in these photons that corresponds to the black lines on a continuous background. ✓
Or similar

(3)

Question 14**(11 marks)**

A spacecraft of rest mass 500 kg is moving away from Earth at a speed of $0.68c$. A light on the spacecraft is flashing 4 times per second in the reference frame of the spacecraft.

- a) Determine the frequency of the flashes for an observer on Earth.

(4)

$v = 0.68c$ rest time $t_0 = 0.25$ s identifies variables correctly ✓

$$t = \frac{t_0}{\sqrt{1 - \frac{v^2}{c^2}}}$$

$$t = \frac{0.25}{\sqrt{1 - \frac{(0.68c)^2}{c^2}}} \quad \checkmark$$

$$t = 0.34097 \quad \checkmark$$

$$\text{Frequency} = \frac{1}{T} = \frac{1}{0.34097} = 2.93 \text{ Hz} \quad \checkmark$$

- b) Calculate the relativistic momentum of the spacecraft from the reference frame of the Earth.

(3)

$v = 0.68 \times 3 \times 10^8 \text{ m s}^{-1}$ $m = 500 \text{ kg}$ identifies variables correctly ✓

$$p_v = \frac{m \cdot v}{\sqrt{1 - \frac{v^2}{c^2}}}$$

$$p_v = \frac{500 \times 0.68 \times 3 \times 10^8}{\sqrt{1 - \frac{(0.68c)^2}{c^2}}} \quad \checkmark$$

$$p_v = 1.39 \times 10^{11} \text{ kg m s}^{-1} \quad \checkmark$$

- c) With reference to the relativistic momentum equation, explain why it is impossible for the spacecraft to travel away from Earth at the speed of light.

(2)

According to the equation

$$p_v = \frac{m \cdot v}{\sqrt{1 - \frac{v^2}{c^2}}}$$

If $v = c$ we obtain an infinite result for momentum ✓

This implies that the mass will be infinite which is not possible for a finite universe. ✓

Or words to that effect.

- d) For an observer on Earth what is the speed of the light flashes as they arrive from the spacecraft? Briefly explain your reasoning.

(2)

The speed of light is still $3.00 \times 10^8 \text{ m s}^{-1}$ ✓

According to Einstein's Special Relativity the speed of light in a vacuum is an absolute constant. ✓

Or words to that effect.

Question 15**(18 marks)**

A block of mass 12.0 kg is sliding down a rough inclined plane. The angle of inclination is 38.0° and the force of friction acting on the block from the plane is 24.4 N.

Block mass 12.0 kg

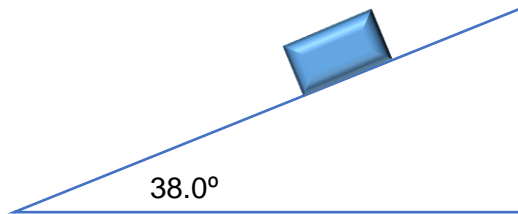

Vector diagram

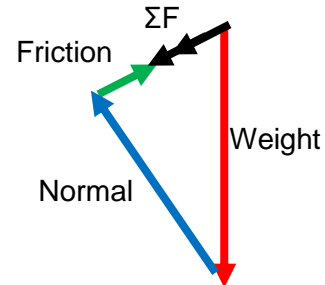

Shows weight, friction and normal reaction ✓ labelled ✓

- a) Draw arrows on the diagram to show the forces acting on the block. Label each of these arrows with the name of the force. (2)
- b) Construct a vector diagram in the hatched box at the right of the diagram and show the sum of forces labelled ΣF . (2)

Correct head to tail ✓ shows ΣF ✓

- c) Calculate the magnitude of the Normal reaction force acting on the block. (2)

$$\text{Normal reaction force} = mg \cos \theta$$

$$N = 12 \times 9.8 \times \cos 38^\circ \checkmark$$

$$N = 92.7 \text{ N perpendicular to plane} \checkmark$$

- d) Calculate the acceleration of the block along the inclined plane. (3)

$$\text{Net force} = mg \sin \theta - \text{Friction}$$

$$\Sigma F = 12 \times 9.8 \times \sin 38 - 24.4 \checkmark \quad \Sigma F = 48.0 \text{ N} \checkmark$$

$$a = \Sigma F / m = 48.0 / 12 = 4.00 \text{ m s}^{-2} \text{ along the slope} \checkmark$$

A Pendulum bob of mass 8 kg is free to swing through a vertical circular arc on the end of a string, as shown on the diagram. You can ignore the mass of the string.

The length l of the pendulum is 3.00 m.

When the bob reaches its lowest point it has a speed of 7.67 m s^{-1} .

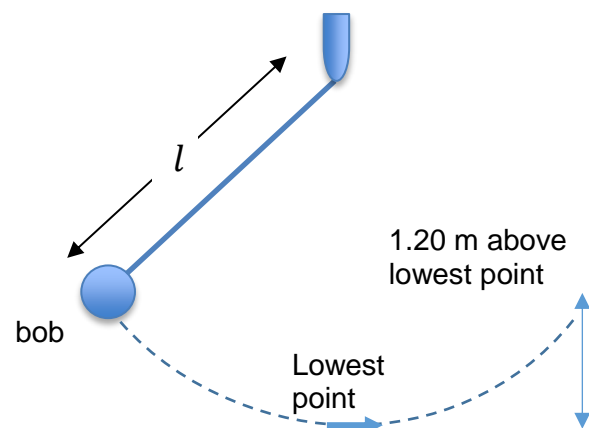

e) Calculate the tension in the string when the pendulum bob is at its lowest point.

(3)

Net force towards centre = $F_{\text{tension}} - \text{weight}$

$$\Sigma F = mv^2/r = F_{\text{tension}} - mg$$

$$F_{\text{tension}} = mv^2/r + mg \checkmark \text{ (correct analysis)}$$

$$F_{\text{tension}} = (8 \times 7.67^2)/3 + (8 \times 9.8) \checkmark$$

$$F_{\text{tension}} = 235 \text{ N along the string} \checkmark$$

f) Determine the speed of the pendulum bob when it has reached a vertical height of 1.20 m above its lowest point.

(3)

By conservation of mechanical energy, TME is constant

$$\text{TME} = mgh_1 + \frac{1}{2} mu^2 = mgh_2 + \frac{1}{2} mv^2$$

$$gh_1 + \frac{1}{2} u^2 = gh_2 + \frac{1}{2} v^2$$

$$9.8 \times 0 + \frac{1}{2} (7.67^2) \checkmark = 9.8 \times 1.20 + \frac{1}{2} v^2 \checkmark$$

$$v = 5.94 \text{ m s}^{-1} \checkmark$$

The pendulum bob is now put into horizontal circular motion at the end of the string. The length of the string (l) is known and the period of rotation (T) can be measured easily.

g) Show by algebraic derivation that the angle θ is related to the period and the length by the following expression:

$$\cos \theta = \frac{gT^2}{4\pi^2 l}$$

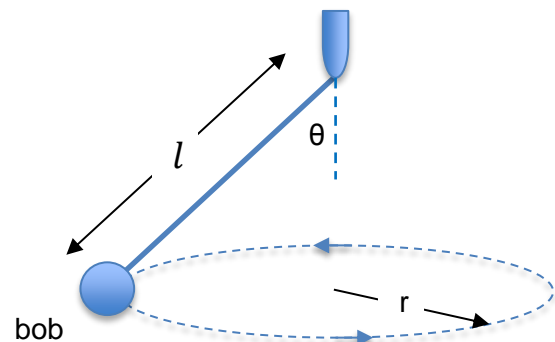

Consider similar triangles: $\sin \theta = \frac{r}{l} = \frac{mv^2}{r} \times \frac{\cos \theta}{mg} \checkmark$

Simplify

$$\frac{r}{l} = \frac{v^2}{r} \times \frac{\cos \theta}{g}$$

Substitute $v = \frac{2\pi r}{T}$

$$\frac{r}{l} = \frac{4\pi^2 r}{T^2} \times \frac{\cos \theta}{g} \checkmark$$

Simplify

$$\frac{1}{l} = \frac{4\pi^2}{T^2} \times \frac{\cos \theta}{g}$$

Re-arrange

$$\cos \theta = \frac{gT^2}{4\pi^2 l} \checkmark$$

(3)

Question 16

(13 marks)

Diagram 1 shows an AC generator. A rectangular coil is being rotated anticlockwise (as viewed from the slip rings) between the magnetic poles. A uniform magnetic field of flux density 0.162 T exists between the magnetic poles. The dimensions of the coil are 18.0 cm by 8.00 cm . The coil has 800 turns of wire and is rotated uniformly at 1440 rpm .

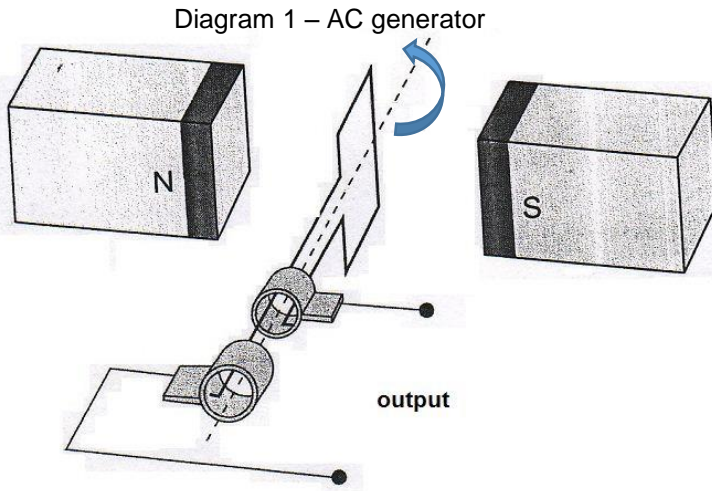
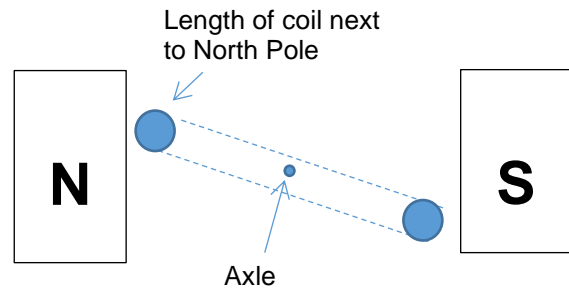

Diagram 2 – The AC generator viewed from the front (location of the slip rings) after the coil has been rotated anticlockwise by 70° from the position shown in Diagram 1.



- a) Consider Diagram 2. What is direction of current in the length of wire next to the North magnetic pole? Circle a response.

Into the page

Out of the page

Impossible to determine

(1)

- b) Briefly describe how you arrived at your answer for the previous question

Out of the page ✓

By Lenz's law. As the coil rotates it is losing flux, current flows in a direction to establish a field that replaces the loss. ✓ Or similar

(1)

- c) At the instant shown in diagram 2, the magnitude of emf is: (circle a response)

Increasing

Zero

Decreasing

Staying Constant

(1)

- d) Explain your response to the previous question.

The rate of change of flux is increasing as the coil approaches zero flux captured by the coil. ✓ emf is directly proportional to the rate of change of flux. ✓ Or similar

(2)

- e) As the coil continues to rotate from the position shown in Diagram 2, the direction of emf will reverse at a certain point. Determine how many degrees from the position shown that this will occur next.

110° ✓

(1)

- f) Calculate the maximum emf (V_{max}) for the AC generator shown in Diagrams 1 and 2.

(3)

$N = 800$ $f = 1440/60 = 24 \text{ Hz}$ $B = 0.162 \text{ T}$ $A = 0.18 \times 0.08 = 0.0144 \text{ m}^2$ ✓
 $V_{max} = NAB2\pi f$
 $V_{max} = 800 \times 0.0144 \times 0.162 \times 2\pi \times 24$ ✓
 $V_{max} = 281.4 = 281 \text{ V}$ ✓

Diagram 3 shows a simple DC motor. It rotates clockwise as viewed from the commutator when the switch is turned on. A uniform magnetic field exists between the magnetic poles. Conducting coil JKLM is connected to the external battery via the split ring commutator.

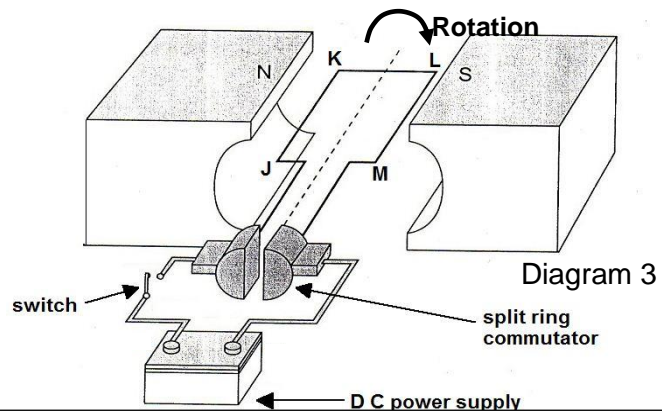

- g) Explain briefly why the torque output of the motor is not constant.

(2)

$Torque = rF\sin\theta$. The force on the wires JK and LM is a constant magnitude and direction, the lever arm from the axle to the lengths JK and LM is constant ✓ but as the coil rotates the angle between the lever arm and the forces varies so Torque varies ✓ or similar valid explanation.

- h) Explain briefly why the net current flowing through the coil decreases as the motor speed increases.

(2)

As the lengths JK and LM are forced to rotate in the field the charge in the wires is cutting through field lines and a back emf is generated that opposes the supply voltage ✓ The higher the rotation speed the greater the back emf ✓ Or similar. (can apply Lenz's law to the coil)

Question 17**(13 marks)**

Fermions are matter particles in the Standard Model. Leptons and Quarks are Fermions. Hadrons are made from quarks. A Baryon is made from 3 quarks and a Meson from 2 quarks. The anti-particle versions of Leptons each have a Lepton number of -1 and opposite charge. All Leptons have a Baryon number of zero.

Tables of some particles are shown below

Lepton	Charge (q_e)	Lepton number	Baryon Number
Electron	-1	1	0
Electron-neutrino	0	1	0
Muon	-1	1	0
Muon-neutrino	0	1	0
Tau	-1	1	0
Tau-neutrino	0	1	0

Quark	Charge (q_e)	Baryon number
Up (u)	$+\frac{2}{3}$	$\frac{1}{3}$
Down (d)	$-\frac{1}{3}$	$\frac{1}{3}$
Top (t)	$+\frac{2}{3}$	$\frac{1}{3}$
Bottom (b)	$-\frac{1}{3}$	$\frac{1}{3}$
Charm (c)	$+\frac{2}{3}$	$\frac{1}{3}$
Strange (s)	$-\frac{1}{3}$	$\frac{1}{3}$

Hadron	Quarks	Mass (MeV/c^2)	Baryon Number	Lepton number
Proton	uud	938.3	+1	0
Neutron	udd	939.6		0
Pion-plus (π^+)	$u\bar{d}$	139.6	0	0
Sigma-plus	uus	1189.4	+1	0
Charmed Omega	ssc	1672.0	+1	0

- a) How is a Lepton different from a Quark in the Standard Model? Explain with reference to force.

(2)

Quarks experience the strong nuclear force ✓

Leptons do not experience the strong nuclear force ✓ (interact via the weak nuclear force)

- b) Determine the Baryon number of a neutron. Show your working.

(1)

Quark composition = u d d

Baryon number = $\frac{1}{3} + \frac{1}{3} + \frac{1}{3} = 1$ ✓

- c) Determine the electric charge of a Charmed-Omega hadron. Show your working.

(2)

Quark composition = $s s c$
 Charge = $(-1/3) + (-1/3) + 2/3 = 0 \checkmark$

- d) Consider the proposed reaction –

A proton decays to a positron and a pion-plus meson $p \rightarrow e^+ + \pi^+$

With reference to Baryon number explain whether this reaction is possible or not.

(2)

Baryon number must be conserved
 Baryon number before = 1 (proton)
 Baryon number after = 0 (positron) + 0 (pion-plus) = 0 \checkmark
 Therefore this is not possible. \checkmark

- e) Consider the proposed reaction –

A neutron decays to a proton, an electron and an anti-neutrino. $n \rightarrow p + e^- + \bar{\nu}$

With reference to Lepton number explain whether this reaction is possible or not.

(2)

Lepton number must be conserved
 Lepton number before = 0 (neutron)
 Lepton number after = 0 (proton) + 1 (electron) - 1 (anti-neutrino) = 0
 \checkmark (N.B. Only electron lepton number is part of this reaction - Tau and Muon lepton numbers are zero before and after)
 Therefore this is possible. \checkmark

- f) Determine the mass of a Charmed-omega hadron in kilograms using scientific notation to 3 significant figures.

(2)

Mass (kg) = $(1672 \times 10^6 \times 1.60 \times 10^{-19}) / (3 \times 10^8)^2 \checkmark$
 Mass (kg) = $2.97 \times 10^{-27} \text{ kg} \checkmark$

- g) Briefly explain why quarks of like charge are not repelled from each other in a hadron.

(2)

Quarks are joined by the strong (nuclear) force (regardless of charge) \checkmark
 The attractive strong (nuclear) force has a greater magnitude than repulsive electromagnetic force \checkmark

Question 18**(15 marks)**

A group of physics students devised an investigation to determine the value of Permittivity in free space – the electric constant ϵ_0 . They set up the equipment shown in the diagram. Two flat parallel aluminium plates could be separately stripped of electrons to give a charge of $2.20 \times 10^{-7} \text{ C}$ on each plate. The bottom plate was placed on a digital balance that read in grams. The balance was tared (set to zero) before the plates were charged. When the plates were charged the balance reading could be converted to the electrostatic force of repulsion experienced by the bottom plate. The top plate was clamped firmly in a plastic stand. The separation r between the plates was set with a Vernier gauge.

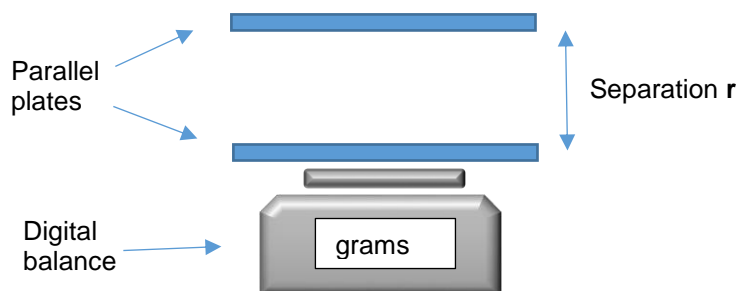

The students referred to the following equation and decided to linearise their data by plotting a graph of Force F on the y-axis versus $\frac{1}{r^2}$ on the x-axis. They determined the value of ϵ_0 by referring to the gradient of the line of best fit.

$$F = \frac{1}{4\pi \epsilon_0} \cdot \frac{q_1 q_2}{r^2}$$

The students decided to work with a relative uncertainty of $\pm 10\%$ for the mass readings. They converted this to an absolute uncertainty for the Force values.

Table of results

Separation r (m)	$\frac{1}{r^2}$ (m^{-2})	Balance reading (grams)	Electrostatic Force (N)
0.065	234	10.51	0.103 ± 0.010
0.070	204	9.18	0.0900 ± 0.009
0.080	156	6.94	0.0680 ± 0.007
0.100	100	4.29	0.0420 ± 0.004
0.120	69.4	3.16	0.031 ± 0.003

a) Complete the second column of the table for $\frac{1}{r^2}$. Two values have been done for you.

(1)

b) Complete the fourth column of the table for Electrostatic force and include the appropriate uncertainty range. Two values have been done for you.

(2)

c) Plot a graph of F versus $\frac{1}{r^2}$. You must include a line of best fit and error bars.

If you need to make a second attempt, spare graph paper is at the end of this question. Indicate clearly if you have used the second graph and cancel the working on the first graph.

(6)

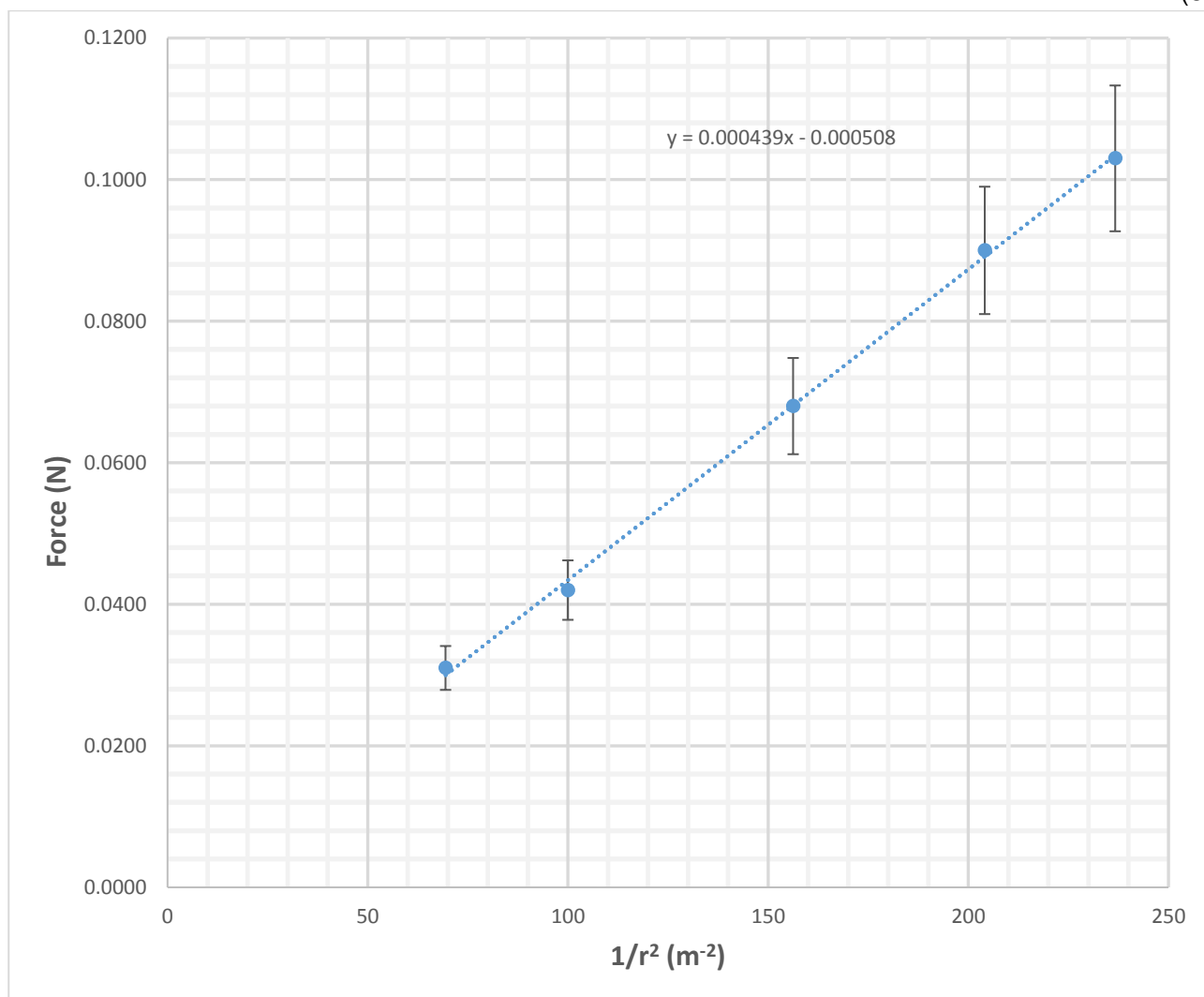

Axes labels ✓
Line of best fit ✓

Axes units ✓
Error bars ✓

Axes Scaling ✓

Accurate plotting ✓

d) Calculate the gradient of your line of best fit from your graph showing all working. (No units are required).

(3)

Clearly show rise and run construction lines on the graph ✓

Example: gradient = $0.108/250$ ✓ = 4.32×10^{-4} ✓
(Points must be taken from the line of best fit)

- e) Determine the experimental value of the electronic constant ϵ_0 from the value of the gradient that you obtained. (If you could not determine the gradient use the numerical value 0.00044).

(3)

$$\begin{aligned} \text{gradient} &= \frac{q_1 q_2}{4\pi \epsilon_0} \quad \checkmark \\ 4.32 \times 10^{-4} &= \frac{2.20 \times 10^{-7} \times 2.20 \times 10^{-7}}{4\pi \epsilon_0} \quad \checkmark \\ \epsilon_0 &= 8.92 \times 10^{-12} \quad \checkmark \quad (\text{Units not required}) \end{aligned}$$

Spare graph paper

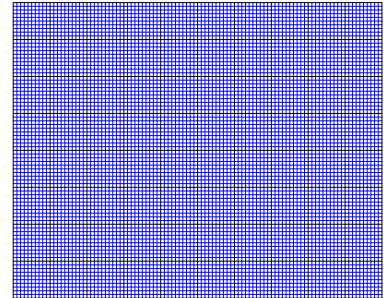

Question 19

(7 marks)

Lead ions (Pb^{2+}) of mass 3.44×10^{-25} kg are doubly charged positive ions. They are accelerated through an electric field between charged parallel plates before entering a vacuum chamber where they are deflected by a magnetic field as shown on the diagram

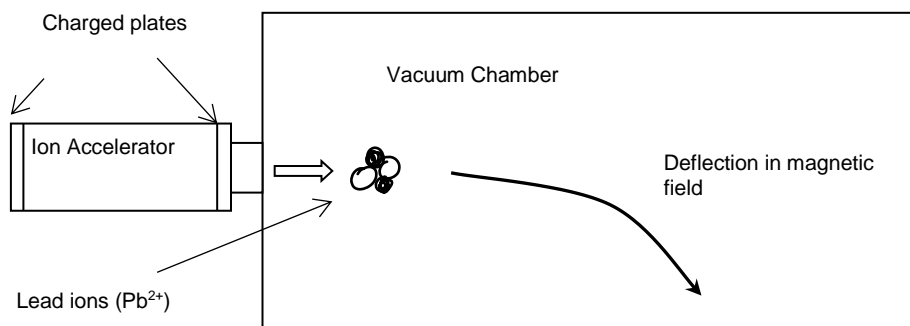

- a) Calculate the potential difference between the charged plates in the Ion Accelerator that will give the lead ions a maximum velocity of 6.40×10^5 m s⁻¹

$$\begin{aligned}
 q &= +3.20 \times 10^{-19} \text{ C} & v &= 6.40 \times 10^5 \text{ m/s} \\
 \text{mass of Lead ion} &= 3.44 \times 10^{-25} \text{ kg} & & \checkmark \\
 W_d = V \cdot q & & \text{Work done} &= \Delta \text{KE} \\
 \frac{1}{2} m v^2 &= V \cdot q & & \\
 V &= \left(\frac{1}{2} m v^2 \right) / q = \left(\frac{1}{2} \cdot 3.44 \times 10^{-25} (6.40 \times 10^5)^2 \right) / +3.20 \times 10^{-19} \checkmark \\
 V &= 220160 = 2.20 \times 10^5 \text{ V} \checkmark
 \end{aligned}$$

(3)

- b) State the direction of the magnetic field within the vacuum chamber that will cause the deflection shown. Circle your response.

Left

Right

Up

Out of page

t of page

(1)

- c) Calculate the magnitude of the magnetic flux density that will deflect the lead ions on a circular path of diameter 24.0 m.

$$\begin{aligned}
 \text{Radius} &= 12.0 \text{ m} & q &= +3.20 \times 10^{-19} \text{ C} \\
 v &= 6.40 \times 10^5 \text{ m/s} & \text{mass of Lead ion} &= 3.44 \times 10^{-25} \text{ kg} \checkmark \\
 \frac{mv^2}{r} &= qvB & & \\
 B &= \frac{mv}{qr} = \frac{3.44 \times 10^{-25} \times 6.40 \times 10^5}{3.20 \times 10^{-19} \times 12} \checkmark \\
 B &= 0.0573 \text{ T} \checkmark
 \end{aligned}$$

(3)

Section Three: Comprehension 20% (36 Marks)

This section contains **two (2)** questions. You must answer both questions. Write your answers in the space provided. Suggested working time for this section is 40 minutes.

Question 20 The scientific model of electromagnetic radiation (18 marks)

A scientific model is a proposal to explain the behaviour of scientific phenomena and to predict the outcomes of interactions. The aim of a scientific model is to make a particular part or feature of the world easier to understand, define and simulate by referencing it to existing and usually commonly accepted knowledge. Scientific models evolve as more evidence becomes available and sometimes those that were previously rejected can be revisited.

Over the centuries scientists have debated whether light is a particle or a wave. Scientific models to explain light are still evolving and competing. In the 1600s Isaac Newton modelled light as a particle called the corpuscle. Because of Newton's success with gravitation this model became more accepted than Huygens wave front theory of the same era.

In 1801 Thomas Young showed that light passing through a double slit formed an interference pattern on a screen. This was evidence for the wave properties of light. Sound and water waves show the same pattern. The wave explanation of Young's double slit demonstration was supported by Fresnel and Poisson who showed that light diffracted, which is very much a wave property.

By the late 1800s the luminiferous ether was the postulated medium for the propagation of light waves. It was a model to explain the ability of light waves to move through the vacuum of space, something that mechanical waves cannot do. However, the Michelson-Morley experiment of 1887 suggested that the ether was non-existent. It had been designed to show the interference of light moving through the ether but this was not demonstrated.

In the 1860s James Clerk Maxwell's theory of electromagnetism showed that electromagnetic waves travel through space at the speed of light. Electromagnetic waves are mutually perpendicular electric and magnetic fields that regenerate each other. This implied that the ether model was not required for the travel of light.

In 1901 it was clear that classical physics could not explain the spectrum of electromagnetic radiation emitted by a black-body. Max Planck proposed the photon model of light, that light energy was only produced in discrete integer packets (quanta). This new particle model allowed an understanding of Black Body spectra.

The photon model also gave an explanation for the Photoelectric effect which was discovered by Heinrich Hertz in 1887 and studied by Planck and Einstein. When light of a certain frequency shines onto a metallic surface, electrons are emitted. If the frequency of the light is below the threshold for that metal no electrons will be emitted even if the light is intense.

In 1924 Louis De Broglie proposed that any particle in motion has an associated wavelength λ .

The De Broglie Equation is: $\lambda = \frac{h}{mv} = \frac{h}{p}$ $h = \text{Planck's constant,}$

$p = mv = \text{momentum (kg m s}^{-1}\text{)}$ where $m = \text{mass (kg)}$ and $v = \text{speed (m s}^{-1}\text{)}$

A photon is a particle of light with no mass. However, light is affected by gravity which indicates that it has momentum. The De Broglie equation allows us to calculate the momentum of a photon. When a photon is absorbed by an atomic electron its energy and momentum are both conserved.

Questions

- a) Why did the model of light as a mechanical wave require the Luminiferous Ether?

(2)

A mechanical wave needs a medium to propagate so should not be able to travel through the vacuum of space. ✓

The luminiferous ether model provides a suitable medium ✓

- b) What change in the understanding of light made it possible to discard the concept of a Luminiferous Ether? Explain briefly

(2)

Maxwell's electromagnetic wave theory. ✓

The oscillating electric and magnetic field regenerate each other even through a vacuum ✓

Reference to Michelson-Morley - 1 mark

- c) What does the word “quantum” in the phrase “Quantum Physics” refer to? Give an example in your explanation.

(2)

Quanta are discrete fixed amounts e.g. Energy (as opposed to continuously variable) ✓

Example: light photons are absorbed as discrete packets of energy to explain photoelectric effect ✓ (or similar valid example)

Or other reasonable explanation that gives an example

- d) Consider the Photoelectric effect. Ultraviolet light of wavelength 208 nm shines on a clean copper plate whose work function is 4.70 eV.

- i. Calculate the maximum kinetic energy of the ejected photoelectrons

(4)

$$\text{Work function (J)} = 4.70 \times 1.60 \times 10^{-19} = 7.52 \times 10^{-19} \text{ J}$$

$$f = \frac{c}{\lambda} = \frac{3 \times 10^8}{208 \times 10^{-9}} \checkmark$$

$$E_k = hf - W$$

$$E_k = \frac{6.63 \times 10^{-34} \times 3 \times 10^8}{208 \times 10^{-9}} - 7.52 \times 10^{-19} \checkmark$$

$$E_k = 2.04 \times 10^{-19} \text{ J} \checkmark$$

- ii. Will light of wavelength 274 nm cause photoelectrons to be emitted from the surface of the metal? You must refer to a calculation to justify your response.

(3)

$$\text{Work function (J)} = 4.70 \times 1.60 \times 10^{-19} = 7.52 \times 10^{-19} \text{ J}$$

Threshold wavelength given by

$$W = hf = \frac{hc}{\lambda}$$

$$7.52 \times 10^{-19} = \frac{6.63 \times 10^{-34} \times 3 \times 10^8}{\lambda} \checkmark$$

$$\lambda \text{ (maximum)} = 2.64 \times 10^{-7} \text{ m} = 264 \text{ nm} \checkmark$$

274 nm > 264 nm therefore it will not eject electrons \checkmark

Or reference to min frequency = 1.136×10^{15} Hz or energy of 7.26×10^{-19} J is less than work function energy

- e) Calculate the De Broglie wavelength for bullet of mass 12.0 g moving at a speed 783 m s⁻¹.

(3)

$$m = 0.012 \text{ kg} \quad v = 783 \text{ m s}^{-1} \checkmark$$

$$\lambda = \frac{h}{mv}$$

$$\lambda = \frac{6.63 \times 10^{-34}}{0.012 \times 783} \checkmark$$

$$\lambda = 7.06 \times 10^{-35} \text{ m} \checkmark$$

- f) Calculate the momentum of a 450 nm blue photon.

(2)

$$\lambda = 450 \times 10^{-9}$$

$$\lambda = \frac{h}{p} \quad p = \frac{h}{\lambda}$$

$$p = \frac{6.63 \times 10^{-34}}{450 \times 10^{-9}} \checkmark$$

$$p = 1.47 \times 10^{-27} \text{ kg m s}^{-1} \checkmark$$

Question 21 The Hubble Space Telescope**(18 marks)**

The Hubble Space Telescope (HST) was launched into a Low Earth Orbit in 1990. It has a mass of 11,110 kg and is cylindrical in shape with a diameter of 4.20 m and a length of 13.2 m. It orbits at an altitude of 559 km above the Earth's surface. This location removes the problem of optical distortion due to the atmosphere that ground based satellites contend with.

The telescope is a Cassegrain reflector that uses a 2.40 m diameter concave mirror. Light from the mirror is directed to one of several instruments on-board. Each instrument works with different portions of the electromagnetic spectrum. The HST is powered by an array of solar panels.

The HST has taken precise measurements of the motion of Ganymede, one of the moons of Jupiter. Ganymede has a mass of 1.48×10^{23} kg. The orbital distance between Ganymede and Jupiter is 1 070 400 km. It takes Ganymede 7 days 3 hours and 42 minutes to orbit.

The HST is a vitally important research tool for astronomy and has resolved many long standing problems. It has also raised new questions requiring new theories to explain them.

The Big Bang theory predicts that the early universe was extremely hot. One second after the Big Bang, the temperature of the universe was about 10 billion degrees and filled with neutrons, protons, electrons, positrons, photons and neutrinos. As it cooled neutrons either combined with protons to make deuterium or decayed into protons and electrons. After three minutes most of the deuterium combined to make helium. This process of light element formation is called "Big Bang nucleosynthesis" (BBN). Light elements are the first few elements in the periodic table. If the Big Bang theory is correct there should be an abundance of light elements in the universe.

The Hubble Space Telescope has collected data from its STIS (Space Telescope Imaging Spectrograph) instrument to confirm the abundance of light elements in the universe.

Research by Alpherin and Herman in 1948 indicated that most elements could not have been made in the early universe. The problem was neutron capture. Isolated neutrons decay with a half-life of about 10 minutes. There was not enough time to build the heavier elements before the neutrons were gone. The heavy elements were made much later within stars. Only the lightest elements were formed in the early universe. A consequence of this work was the prediction of cosmic microwave background (CMB) radiation.

The Big Bang theory predicts a very hot early universe. As it expands the gas within it cools. Therefore the universe should be filled with radiation which is the remnant heat left over from the Big Bang. After such a large amount of time the radiation temperature is now only 2.725 Kelvin and primarily in the microwave portion of the electromagnetic spectrum. Hence its name "cosmic microwave background", or CMB.

Measurements by other space observatories such as COBE and WMAP have given accurate confirmation of the Cosmic Microwave Background.

One of Hubble's primary objectives was to accurately measure the distance to Cepheid Variable stars to reduce the uncertainty for the value of the Hubble constant. Before the HST the relative uncertainty for the Hubble Constant was $\pm 50\%$. This meant that the age of the universe could have been any value between 10 and 20 billion years old. The HST measurements reduced this uncertainty to $\pm 10\%$.

Whilst the HST was able to give more accurate measurements for the age of the universe it has also raised doubts about its future. For example measurements of distant Supernovae indicate that the expansion of the universe appears to be accelerating rather than decelerating under the influence of gravity as was initially proposed by the Big Bang Theory. The cause of this acceleration is not well understood and has been attributed to the new theory of Dark Energy.

Questions

- a) Calculate the gravitational field strength of the Earth at the location of the Hubble Space Telescope.

$$m = 5.97 \times 10^{24} \quad r = 6.37 \times 10^6 + 559\,000 = 6.929 \times 10^6 \text{ m} \quad \checkmark$$

(3)

$$g = G \frac{M}{r^2}$$

$$g = 6.67 \times 10^{-11} \frac{5.97 \times 10^{24}}{(6.929 \times 10^6)^2} \quad \checkmark$$

$$g = 8.29 \text{ N kg}^{-1} \quad \checkmark$$

- b) Calculate the orbital speed of the Hubble Space Telescope.

$$m = 5.97 \times 10^{24} \quad r = 6.38 \times 10^6 + 559\,000 = 6.939 \times 10^6 \text{ m}$$

field strength = centripetal acceleration

(3)

$$G \frac{M}{r^2} = \frac{v^2}{r} \quad \text{by rearrangement} \quad v = \sqrt{\frac{GM}{r}} \quad \checkmark$$

$$v = \sqrt{6.67 \times 10^{-11} \frac{5.97 \times 10^{24}}{6.939 \times 10^6}} \quad \checkmark$$

$$v = 7.58 \times 10^3 \text{ m s}^{-1} \quad \checkmark$$

- c) Calculate the mass of Jupiter according to the motion data of its orbiting moon Ganymede.

$$r = 1\,070\,400\,000 \text{ m} \quad \checkmark$$

$$T = 7 \text{ days } 3 \text{ hours and } 42 \text{ minutes} = 618\,120 \text{ s} \quad \checkmark$$

field strength = centripetal acceleration

$$\frac{T^2}{r^3} = \frac{4\pi^2}{GM} \quad \text{by rearrangement} \quad M = \frac{4\pi^2 r^3}{GT^2}$$

(4)

$$M = \frac{4 \times \pi^2 \times 1\,070\,400\,000^3}{6.67 \times 10^{-11} \times 618\,120^2} \quad \checkmark$$

$$M = 1.90 \times 10^{27} \text{ kg} \quad \checkmark$$

- d) Explain why heavier elements from the periodic table could not have been formed in the early universe.

(2)

Heavier elements require many neutrons in their nucleus. ✓
Isolated neutrons have a short half-life and decay to protons and electrons before they can be incorporated into new elements. ✓
(neutron capture) Or 2 similar acceptable points

- e) The passage refers to scientific data that the Hubble Space Telescope and other space observatories collect. Describe three (3) types of data from the passage that can be used to support the Big Bang Theory.

(3)

Measurement from STIS to confirm the abundance of light elements ✓

Accurate measurement of Cosmic Microwave Background by COBE and WMAP. ✓

More accurate measurements of distance to Cepheid Variable stars to reduce the uncertainty of the Hubble Constant. ✓

Note - red shift is not cited in this passage

- f) Describe an example from the passage where the Hubble Space Telescope has made an astronomical discovery which requires new theories to provide an explanation.

(3)

Measurement of distant supernovae that indicate that the expansion of the universe is accelerating ✓ rather than being decelerated by the attractive force of gravity. ✓

New theory of dark energy to explain this. ✓

Any 3 good separate points.

END OF EXAMINATION

